

CORE X71

Your Build. Our Core

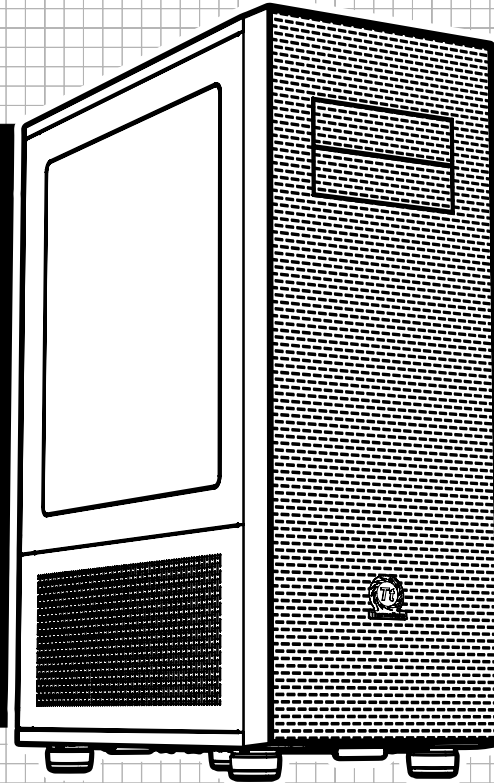

User's Manual
Benutzerhandbuch
Mode d'emploi
Manual del usuario
Manuale dell'utente
Manual do Utilizador
安裝說明書
用戶手冊
ユーザーズマニュアル
Руководство пользователя
kullanıcı elkitabı
(EEE Yönetmeliğine Uygundur)
คู่มือการใช้



© 2016 Thermaltake Technology Co., Ltd. All Rights Reserved. 2016.11
All other registered trademarks belong to their respective companies. www.thermaltake.com

Join Tt Community To Receive Benefits



Dear Valued Customer,
Thank you for choosing Thermaltake.
As a new user we value your thoughts and opinions and your feedback is important to us. We at Thermaltake would like to use this opportunity to invite you to join our Community Forums. Register today to start enjoying the full benefits of our community.



Benefits of being a member:

- Quick and responsive user support
- Receive help and advice with new builds
- Keep up to date with new product releases
- Share your thoughts and builds with the community
- Enter monthly contests and giveaways

Tt LCS-Liquid Cooling Support Certification



Tt LCS Certified is a Thermaltake exclusive certification applied to only products that pass the design and hardcore enthusiasts standards that a true LCS chassis should be held to. The Tt LCS certification was created so that we at Thermaltake can designate to all power users which chassis have been tested to be best compatible with extreme liquid cooling configurations to ensure you get the best performance from the best features and fitment.

Brand official website
<http://www.thermaltake.com/>

Global Facebook
<https://www.facebook.com/ThermaltakeInc>

Taiwan Facebook
<http://www.facebook.com/ThermaltakeTW>

Global community forums
<http://community.thermaltake.com>

CONTENTS

Chapter 1. Product Introduction

1.0	Specification	01
1.1	Accessory	01
1.2	Warning and Notice	02

Chapter 2. Installation Guide

2.0	Side Panels Disassembly	04
2.1	Power Supply Unit (PSU) Installation	05
2.2	Motherboard Installation	06
2.3	5.25" Device Installation	07
2.4	3.5" & 2.5" HDD Installation	08
2.5	PCI Card Installation	10
2.6	Air Cooling Installation	12
2.7	Liquid Cooling Installation	13
2.8	Filter Installation	15













Chapter3 Leads Installation Guide

3.0	Case LED connection	16
3.1	USB 3.0 connection	16
3.2	Audio connection	16

Specification

Case Type	Full Tower
Dimension (H*W*D)	677 x 250 x 511 mm (26.7 x 9.8 x 20.1 inch)
Material	SPCC
Fan Support	Front : 3 x 120mm, 3 x 140mm, 2 x 200mm Top : 3 x 120mm, 3 x 140mm, 2 x 200mm Rear : 1 x 120mm, 1 x 140mm Bottom : 2 x 120mm, 2 x 140mm Left / Right Side: 3 x 120mm, 2 x 140mm
Radiator Support	Front : 1 x 480mm, 1 x 420mm Top : 1 x 360mm, 1 x 280mm Rear : 1 x 120mm, 1 x 140mm Bottom : 1 x 120mm, 1 x 140mm Left / Right Side: 1 x 360mm, 1 x 280mm
Clearance	CPU cooler height limitation: 180mm VGA length limitation: 278mm(with HDD rack) 420mm(without HDD rack) PSU length limitation: 180mm (With Bottom Fan) 220mm (Without Bottom Fan)

Accessory

Figure	Parts Name	Q'ty	Used for
	Stand-off # 6-32 x 6mm	2	Motherboard
	Screw # 6-32 x 6mm	4	Power
	Screw # 6-32 x 5mm	12	3.5"HDD
	Rubber	12	3.5"HDD
	Screw M3 x 5mm	22	Motherboard, 2.5"HDD
	Nut Setter	1	Stand-off
	Screw Ø5 x 12mm	4	Case Fan
	Cable Tie	5	Cable Management
	Buzzer	1	Motherboard Alarm
	Low Noise Cable	2	Fan
	8-pin Extension Cable	1	Power Connector Extension Cable
	Fan Bracket	4	Fan
	Power Rubber	4	PSU

Warning and Notice

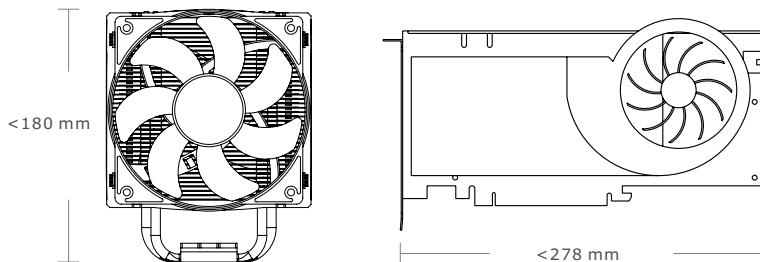

Warning!!

CPU Cooler Height Limitation:

Please ensure that your CPU cooler does NOT exceed 180mm (7.1 inches) height.

VGA (Add-on card) Length Limitation:

Please ensure that your VGA (Add-on card) does NOT exceed 278mm (10.9 inches) length.

Warnung!!

CPU-Kühler Höhenbeschränkung:

Bitte stellen Sie sicher, dass Ihr CPU-Kühler 180 mm (7,1 Zoll) Höhe nicht überschreitet.

VGA (Add-on-Karte) Längenbeschränkung:

Bitte stellen Sie sicher, dass Ihre VGA (Add-on-Karte) 278 mm (10,9 Zoll) Länge nicht überschreitet.

Avertissement !

Limite de hauteur du ventilateur de CPU :

Vérifiez que la hauteur du ventilateur de CPU ne dépasse pas 180 mm.

Limite de longueur de la carte (complémentaire) VGA :

Vérifiez que la longueur de votre carte (complémentaire) VGA ne dépasse pas 278 mm

Precaución

Limitación de altura del refrigerador de CPU:

Asegúrese de que la altura de su refrigerador de CPU no excede los 180 mm (7,1 pulgadas).

Limitación de longitud de la tarjeta de vídeo (adicional):

Asegúrese de que la longitud de su tarjeta de vídeo (adicional) no excede los 278 mm (10,9 pulgadas).

Attenzione!

Limitazione altezza dissipatore CPU:

Assicurarsi che l'altezza del dissipatore CPU NON superi 180 mm (7,1 pollici).

Limitazione lunghezza VGA (scheda aggiuntiva):

Assicurarsi che la lunghezza del VGA (scheda aggiuntiva) NON superi 278 mm (10,9 pollici).

Atenção!!

Limite de altura para o dissipador do CPU:

O limite de altura para o dissipador do CPU é 180 mm (7,1 polegadas).

Limite de comprimento para VGA (placa gráfica):

O limite de comprimento para VGA (placa gráfica) é 278 mm (10.9 polegadas).

警告！！

CPU 冷卻器的高度限制：

請確保 CPU 冷卻器的高度不超過 180 mm (7.1 英寸)。

VGA (附加介面卡) 的長度限制：

請確保 VGA (附加介面卡) 的長度不超過 278 mm (10.9 英寸)。

警告！！

CPU 散熱器高度限制：

請確保 CPU 散熱器的高度不超過 180 mm (7.1 英寸) 。

VGA (附加卡) 長度限制：

請確保 VGA (附加卡) 的長度不超過 278 mm (10.9 英寸) 。

警告

CPUクーラーの高さ制限:

CPUクーラーの高さが180mmを超えていないことを確認してください。

VGA (アドオンカード) の長さ制限:

VGA (アドオンカード) の長さが278mmを超えていないことを確認してください。

Внимание!

Ограничение по высоте охладителя ЦП

Убедитесь, что высота охладителя ЦП (центрального процессора) НЕ превышает 180 мм (7,1 дюйма).

Ограничение по длине видеокарты VGA (плата расширения)

Убедитесь, что длина видеокарты VGA (плата расширения) НЕ превышает 278 мм (10,9 дюйма).

Uyar!!

CPU Soğutucu Yükseklik Sınırlaması:

Lütfen CPU soğutucunuzun yüksekliğinin 180mm'yi (7,1 inç) GEÇMEDİĞİNDEN emin olun.

VGA (Eklenli kart) Uzunluk Sınırlaması:

Lütfen VGA'nızın (Eklenli kart) uzunluğunun 278mm'yi (10,9 inç) GEÇMEDİĞİNDEN emin olun.

คำเตือน!!

ขีดจำกัดความสูงสำหรับฮีตซิงก์ของ CPU:

ขีดจำกัดความสูงสำหรับฮีตซิงก์ของ CPU คือ 180 มม. (7.1 นิ้ว)

ขีดจำกัดความยาวสำหรับ VGA (การ์ดแสดงผล):

ขีดจำกัดความยาวสำหรับ VGA (การ์ดแสดงผล) คือ 278 มม. (10.9 นิ้ว)

Side Panels Disassembly

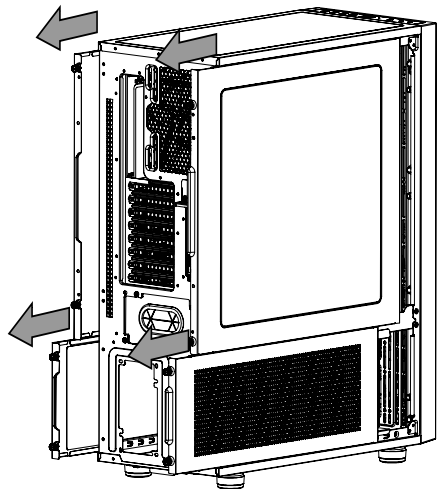

English /
Remove the screws on the back of the chassis,
and open the side panel

Deutsch /
Entfernen Sie die Schrauben auf der Rückseite
des Gehäuses und öffnen Sie das Seitenteil

Français /
Enlevez les vis à l'arrière du châssis et ouvrez le
panneau latéral

Español /
Extraiga los tornillos de la parte posterior de la
caja y abra el panel lateral

Italiano /
Rimuovere le viti sulla parte posteriore dello
chassis e aprire il pannello laterale

Português /
Remova os parafusos na parte de trás da caixa e
abra o painel lateral

繁體中文 /
移除機殼後方螺絲，將側窗打開

简体中文 /
卸除机壳后方螺丝，将侧窗打开

日本語 /
シャーシ背面のねじを取り外し、サイドパネ
ルを開きます

Русский /
Открутите винты на задней стенке корпуса
и откройте боковую панель

Türkçe /
Kasanın arkasındaki vidaları çıkarın ve yan
paneli açın

ภาษาไทย /
ถอดสกรูที่ด้านหลังของแชสซีส์
แล้วเปิดแผงด้านข้าง

Power Supply Unit (PSU) Installation

Position A

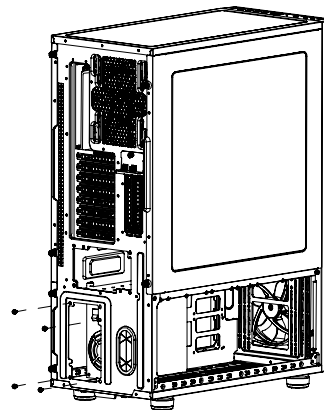

English /
Place the PSU in proper location.

Deutsch /
Platzieren Sie das Netzteil in der richtigen Position.

Français /
Placez l'alimentation dans la position appropriée.

Español /
Instale la PSU en la ubicación correcta.

Italiano /
Posizionare la PSU in modo corretto.

Português /
Coloque o PSU na sua devida posição.

Position B

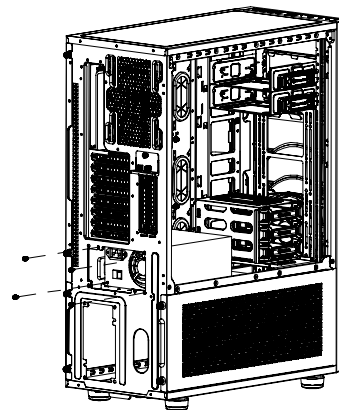

繁體中文 /
將電源供應器放在正確的位置

简体中文 /
將電源供應器放在正確的位置

日本語 /
PSUを適切なロケーションに取り付けます。

Русский /
Установите блок питания в надлежащее место.

Türkçe /
PSU'yu, uygun konuma yerleştirin.

ภาษาไทย /
วาง PSU ในตำแหน่งที่เหมาะสม

Motherboard Installation

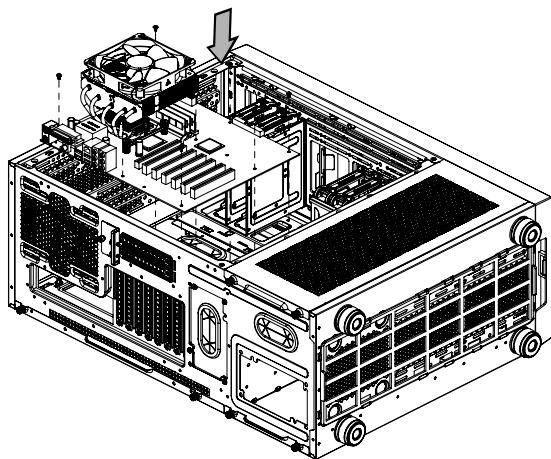

English /

1. Lay down the chassis.
2. Install the motherboard in proper location and secure it with screws.

Deutsch /

1. Legen Sie das Gehäuse auf die Seite.
2. Installieren Sie die Hauptplatine in ihrer vorgesehenen Position und sichern Sie sie mit Schrauben.

Français /

1. Posez à plat le châssis.
2. Installez la carte mère dans l'endroit approprié et sécurisez-la avec des vis.

Español /

1. Tumbé el chasis.
2. Instale la placa madre en la ubicación adecuada y asegúrela con tornillos.

Italiano /

1. Poggiare lo chassis.
2. Installare la scheda madre nella posizione appropriata e fissarla con le viti.

Português /

1. Deixe a caixa.
2. Instale a motherboard no local adequado e aparafuse.

繁體中文 /

1. 將機殼平放。
2. 將主機板放置在合適的位置並用零件包中之螺絲固定。

簡體中文 /

1. 放平机箱。
2. 在合适的位置安装主板并以螺丝安全固定。

日本語 /

1. シャーシを下に置きます。
2. マザーボードを適切な場所に取り付け、ねじで固定します。

Русский /

1. Раскройте системный блок.
2. Установите материнскую плату в надлежащее место и закрепите ее винтами.

Türkçe /

1. Kasayı yan yatırın.
2. Ana kartı uygun konuma takın ve vidalarla sabitleyin.

ภาษาไทย /

1. วางแชสซีส์นอนลง
2. ติดตั้งเมนบอร์ดในตำแหน่งที่เหมาะสม แล้วขันสกรูยึดให้แน่น

5.25" Device Installation

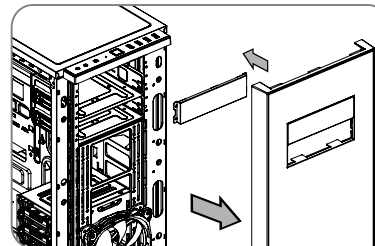

English /

1. Remove the 5.25" drive bay cover.
 2. Slide the 5.25" device into the drive bay to lock the device.
- Note: Press the 5.25" tool-free mechanism to unlock the device.

Deutsch /

1. Entfernen Sie die Abdeckung des 5,25 Zoll Laufwerksschachts.
 2. Schieben Sie the 5,25 Zoll Einheit in den Laufwerksschacht, um die Einheit zu sperren.
- Anmerkung: Drücken Sie den 5,25 Zoll werkzeuglosen Mechanismus, um die Einheit zu verriegeln.

Français /

1. Enlevez le couvercle de la baie de lecteur de 5,25".
2. Faites glisser le périphérique de 5,25" dans la baie de lecteur.

Remarque : Appuyez sur le mécanisme sans outil de 5,25" pour déverrouiller le périphérique.

Español /

1. Extraiga la tapa del hueco de la unidad de 5,25".
 2. Meta el dispositivo de 5,25" en el hueco de la unidad para cerrar el dispositivo.
- Nota: Presione el mecanismo libre de herramienta de 5,25" para abrir el dispositivo.

Italiano /

1. Rimuovere il coperchio dell'alloggiamento vano unità da 5,25".
 2. Fare scorrere il dispositivo da 5,25" nell'alloggiamento dell'unità per bloccare il dispositivo.
- Nota: Premere il meccanismo tool-free da 5,25" per sbloccare il dispositivo.

Português /

1. Remova a cobertura da baía da unidade de 5,25".
 2. Deslize o dispositivo de 5,25" para a baía da unidade, para bloquear o dispositivo.
- Nota: Pressione o mecanismo de 5,25" sem utilizar ferramentas para desbloquear o dispositivo.

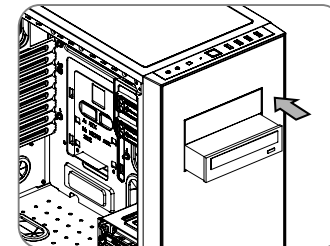

繁體中文 /

1. 移除5.25"擴充槽檔板
 2. 將5.25"裝置至適當的位置
- 注意: 如需移除5.25"裝置, 先按壓5.25"無螺絲機構, 再將5.25"裝置往前推出。

簡體中文 /

1. 移除5.25"槽蓋
 2. 將5.25"設備滑入驅動器槽
- 注意: 如需移除5.25"設備, 先按壓5.25"免工具機械裝置, 再將5.25"設備往前推出

日本語 /

1. 5.25"ドライブベイのカバーを取り外します。
 2. 5.25"デバイスをドライブベイにスライドさせてデバイスをロックします。
- 注: 5.25"工具不要メカニズムを押してデバイスをアンロックします。

Русский /

1. Снимите крышку отсека для 5,25-дюймовых дисководов.
 2. Вставьте 5,25-дюймовое устройство в отсек дисководов для фиксации.
- Примечание. Нажмите на не требующий использования инструментов механизм отсека для 5,25-дюймовых дисководов, чтобы разблокировать устройство.

Türkçe /

1. 5,25" sürücü bölmesi kapağını çıkarın.
 2. 5,25" aygıtını kilitlemek için sürücü bölgesinin içine doğru kaydırın.
- Not: Aygıtın kilidini açmak için 5,25" araçsız mekanizmayı bastırın.

ภาษาไทย /

1. ถอดฝาปิดช่องไดรฟ์ขนาด 5.25" ออก
 2. เลื่อนอุปกรณ์ขนาด 5.25" เข้าไปในช่องไดรฟ์เพื่อล็อกอุปกรณ์
- หมายเหตุ: กดตัวล็อกเครื่องมือขนาด 5.25" เพื่อปลดล็อกอุปกรณ์

3.5" & 2.5" HDD Installation

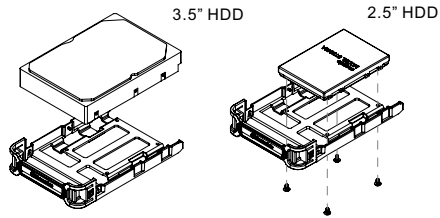

Type A

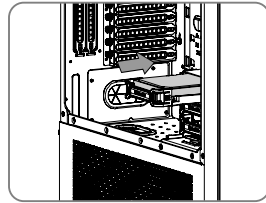

Type B

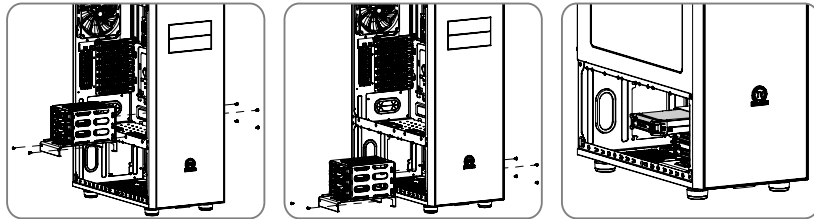

Type C

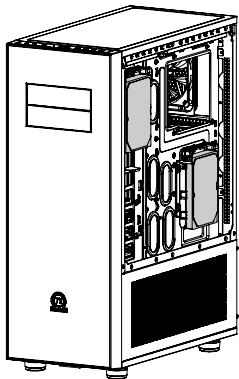

Type D ODD Tray Installation

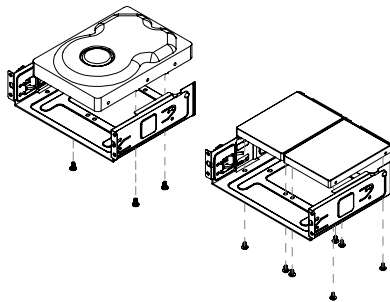

English /

1. Pull the HDD tray out.
2. Place the 2.5" or 3.5" hard drive on the tray and secure it with screws.
3. Slide the HDD tray back to the HDD cage.

Deutsch /

1. Ziehen Sie den HD-Schacht heraus.
2. Montieren Sie die 2,5 oder 3,5 Zoll Festplatte im Schacht und sichern Sie sie mit Schrauben.
3. Schieben Sie den Schacht wieder in den Festplattenkäfig.

Français /

1. Enlevez le boîtier du disque dur.
2. Placez le disque dur de 2,5" ou de 3,5" dans le boîtier et fixez-le avec des vis.
3. Refaites glisser le boîtier du disque dur dans la cage de disques durs.

Español /

1. Extraiga la bandeja del disco duro.
2. Coloque el disco duro de 2'5" ó 3'5" en la bandeja y fíjelo con los tornillos.
3. Vuelva a meter la bandeja del disco duro en su hueco.

Italiano /

1. Estrarre il vano HDD.
2. Posizionare il disco fisso da 2,5" o 3,5" nel vano e fissarlo con le viti.
3. Fare scorrere l'HDD indietro verso la struttura a gabbia HDD.

Português /

1. Puxe a bandeja do disco rígido para fora.
2. Coloque o disco rígido de 2,5" ou 3,5" na bandeja e fixe com parafusos.
3. Deslize a bandeja do disco rígido de volta para a caixa do disco rígido.

繁體中文 /

1. 將硬碟托盤取出
2. 將2.5"或3.5"硬碟放置在硬碟托盤上，用螺絲固定硬碟
3. 將硬碟托盤放回硬碟磁架中

简体中文 /

1. 将硬盘托盘取出
2. 将2.5"或3.5"硬盘放置在硬盘托盘上，用螺丝固定硬盘
3. 将硬盘托盘放回硬盘磁架中

日本語 /

1. HDDトレイを引き出して外します。
2. 2.5インチHDD、SSDもしくは3.5インチHDDドライブをトレイにネジで固定します。
3. HDDトレイをHDDケージに戻します。

Русский /

1. Вытяните лоток для жестких дисков.
2. Установите 2,5- или 3,5-дюймовый жесткий диск в лоток и закрепите его винтами.
3. Установите лоток для жестких дисков обратно в каркас.

Türkçe /

1. HDD tepsinini dışarı çekin.
2. 2,5" veya 3,5" sabit disk sürücüsünü tepsinin üzerine yerleştirin ve vidalarla sabitleyin.
3. HDD tepsinini HDD kafesine geri yerleştirin.

ภาษาไทย /

1. ดึงถาด HDD ออกมา
2. วางฮาร์ดดิสก์ขนาด 2.5" หรือ 3.5" ลงบนถาดแล้วขันสกรูยึดให้แน่น
3. เลื่อนถาด HDD กลับเข้าในโครง HDD

PCI Card Installation

Type A

Direct installing to Motherboard

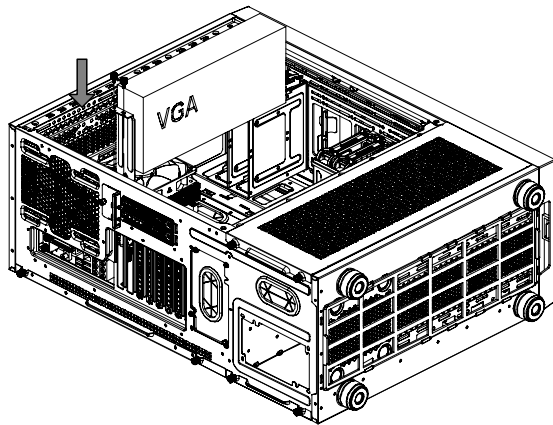
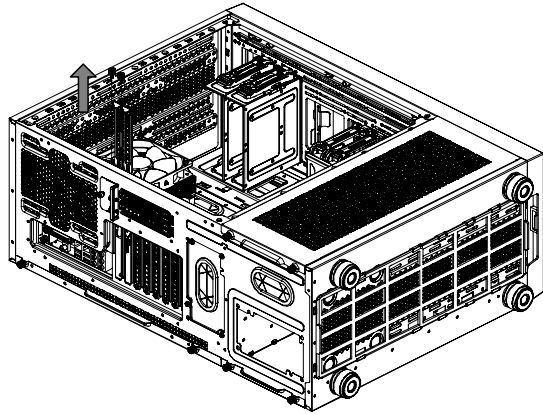

Type B (Optional)

Extend installing to Motherboard (PCI-E Cable Not Included)

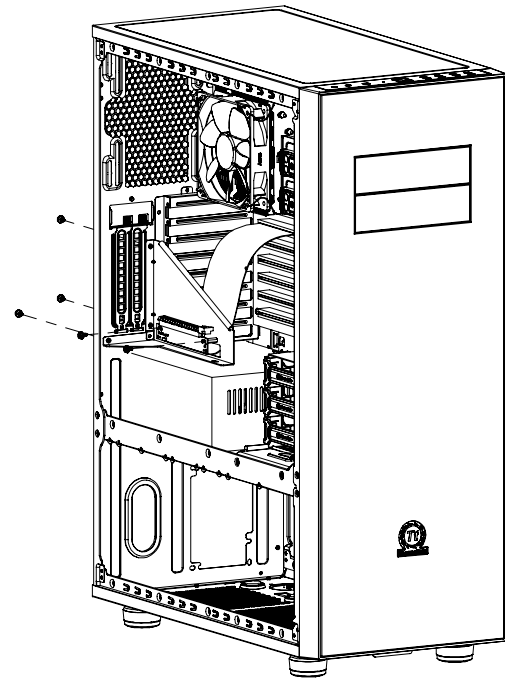

Air Cooling Installation

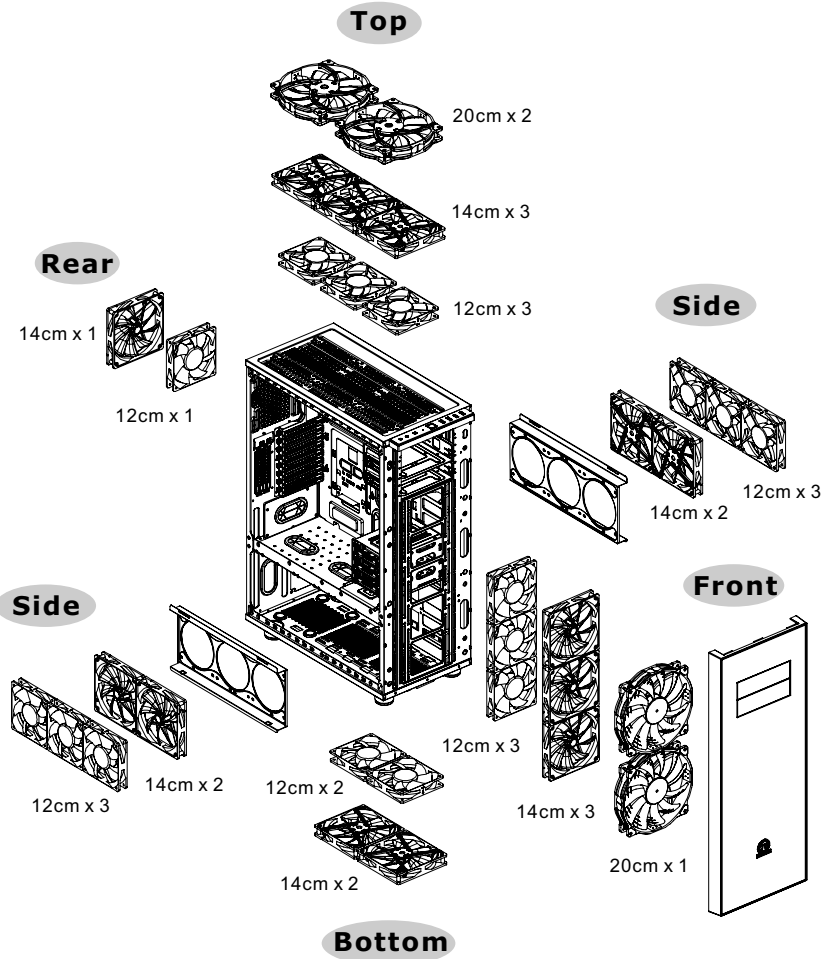

Liquid Cooling Installation

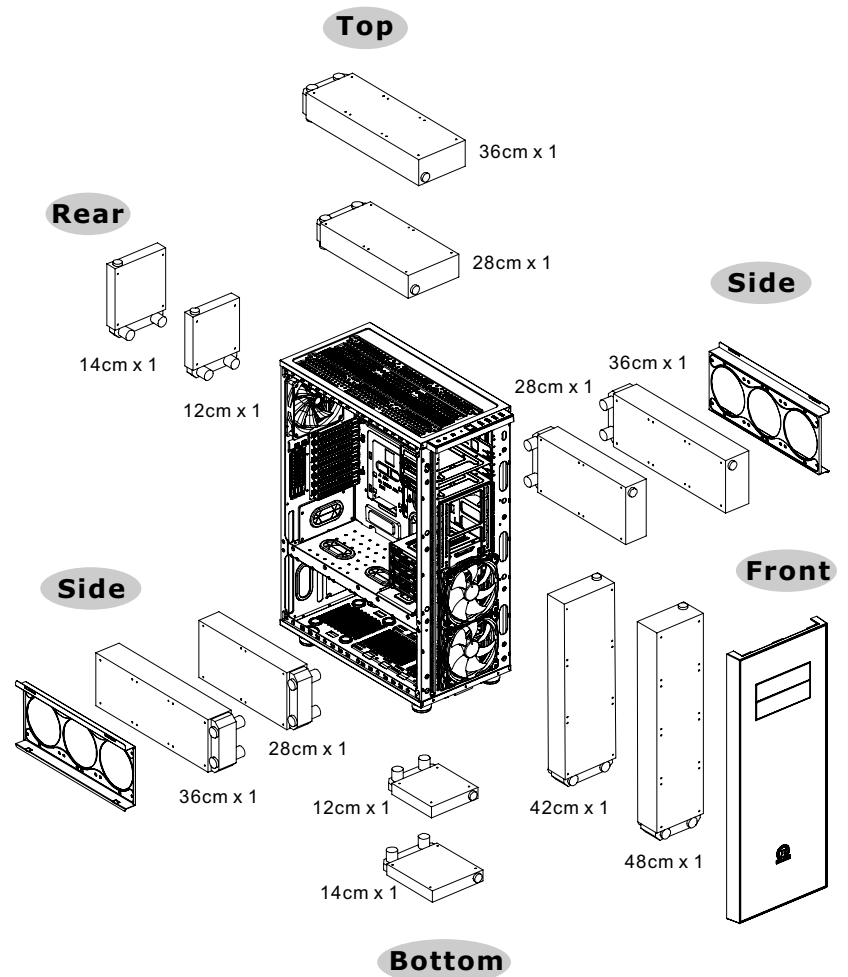

Maximum Radiator Installation Notice

Top Radiator Installation Notice

* Please consult radiator & memory height for proper installation

安裝前請參考水冷排與記憶體高度

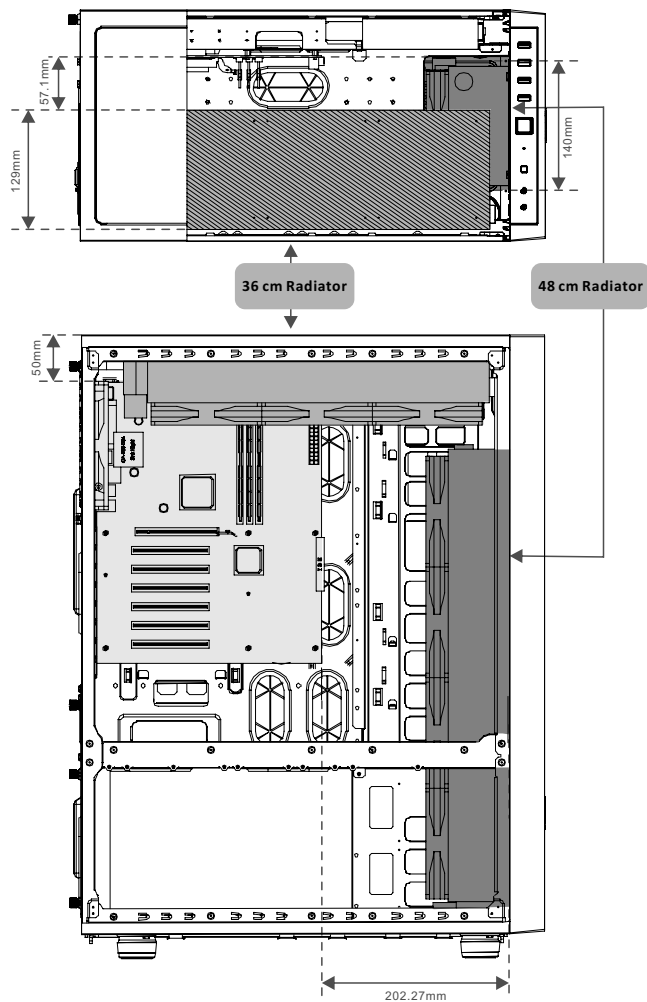

Filter Installation

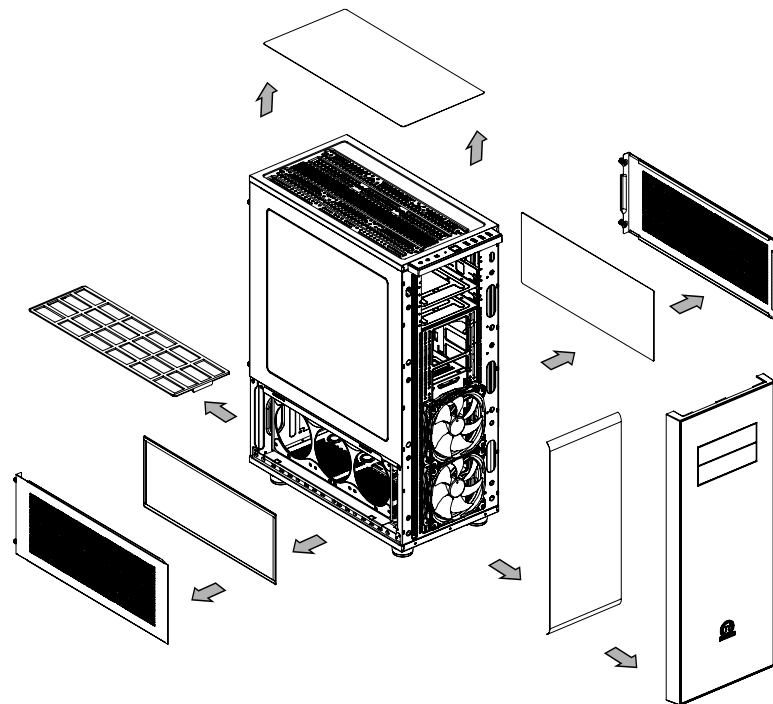

Leads Installation

English

Leads Installation Guide

Case LED Connection / On the front of the case, you can find some LEDs and switch leads. Please consult your user manual of your motherboard manufacturer, then connect these leads to the panel header on the motherboard.

USB 2.0 Connection / Please consult your motherboard manual to find out the section of "USB connection".

USB 3.0 connection /

1. Make sure your motherboard supports USB 3.0 connection.
2. Connect the USB 3.0 cable to the available USB 3.0 port on your computer.

Audio Connection / Please refer to the following illustration of Audio connector and your motherboard user manual. Please select the motherboard which used AC'97 or HD Audio (Azalia), (be aware of that your audio supports AC'97 or HD Audio (Azalia)) or it will damage your device(s).

Deutsch

Anschlüsse herstellen

Gehäuse-LED-Verbindungen / Auf der Gehäusevorderseite finden Sie einige LEDs und Verbindungen. Bitte nehmen Sie die Gebrauchsanweisung Ihres Motherboard Herstellers zur Hilfe und schließen Sie diese Verbindungen an die Panel Header Belegung des Motherboards an.

USB 2.0 Anschluss / Bitte nehmen Sie die Gebrauchsanweisung Ihres Motherboards zur Hilfe und lesen Sie unter dem Kapitel „USB Anschlüsse“ nach.

USB 3.0 Anschluss /

1. Stellen Sie sicher, dass Ihre Hauptplatte den USB 3.0 Anschluss unterstützt.
2. Verbinden Sie das USB 3.0 Kabel mit dem USB 3.0 Port auf Ihrem Computer.

Audio Anschlüsse / Bitte beachten Sie die folgende Abbildung der Audio Anschlüsse und die Anweisung in der Gebrauchsanweisung Ihres Motherboards. Bitte wählen Sie das Motherboard, das AC'97 oder HD Audio (Azalia) verwendet, (achten Sie darauf, dass Ihr Audio AC'97 bzw. HD Audio (Azalia unterstützt)). Andernfalls entstehen schwere Schäden an Ihrem(n) Gerät(en)!!!

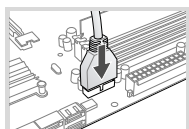
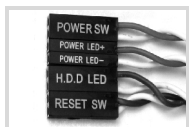

USB 3.0 Connection

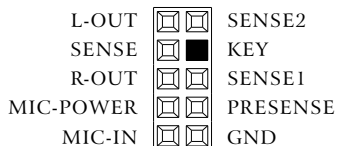

AUDIO AZALIA Function

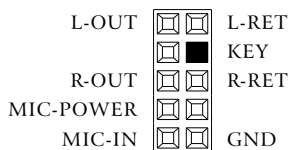

AUDIO AC'97 Function

Français

Guide d'installation des fils

Connexion des voyants du boîtier / Sur la face avant du boîtier, vous trouverez plusieurs voyants et les fils des boutons. S'il vous plaît consultez le guide d'utilisateur du fabricant de votre carte mère, puis connectez ces fils aux connecteurs sur la carte mère.

Connexion USB 2.0 / S'il vous plaît consultez le manuel de votre carte mère à la section "Connexion USB"

Connexion USB 3.0 /

1. Vérifiez que votre carte mère prend en charge la connexion USB 3.0.
2. Connectez le câble USB 3.0 au port USB 3.0 disponible sur votre ordinateur.

Connexion Audio / S'il vous plaît référez vous à l'illustration suivante du connecteur audio et au guide de l'utilisateur de votre carte mère. S'il vous plaît sélectionnez une carte mère supportant AC'97 ou HD Audio (Azalia), (faites attention que votre audio supporte l'AC'97 ou HD Audio (Azalia)) sinon cela pourrait endommager votre matériel.

Español

Guía de Instalación de Cables

Conexión del LED de la caja / En la parte frontal de la caja, encontrará algunos LED y cables de interruptores. Consulte el manual del usuario del fabricante de la placa madre, a continuación conecte estos cables al conector de la placa madre.

Conexión USB 2.0 / Consulte el manual de la placa madre para obtener más información sobre el apartado "Conexión USB"

Conexión USB 3.0 /

1. Asegúrese de que la placa base admite conexión USB 3.0.
2. Conecte el cable USB 3.0 al puerto USB 3.0 disponible en el equipo.

Conexión de Audio / Consulte la siguiente ilustración del conector de Audio y el manual del usuario de la placa madre. Seleccione la placa madre que utiliza AC'97 o HD Audio (Azalia), (asegúrese de que su audio admite AC'97 o HD Audio (Azalia)) si no, sus dispositivos resultarán dañados

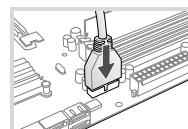

USB 3.0 Connection

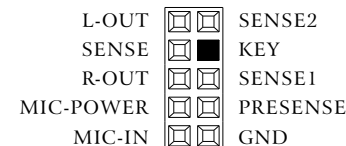

AUDIO AZALIA Function

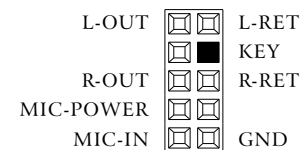

AUDIO AC'97 Function

Italiano

Guida di installazione dei contatti

Connessione del LED del case / Nella parte anteriore del case, sono presenti alcuni contatti per interruttori e LED. Consultare il manuale utente del produttore della scheda madre, quindi connettere i contatti alla parte superiore del pannello sulla scheda madre.

Connessione USB 2.0 / Consultare il manuale per la scheda madre che comprende la sezione relativa alla "connessione USB".

Connessione USB 3.0 /

1. Accertarsi che la scheda madre supporti la connessione USB 3.0.
2. Collegare il cavo USB 3.0 alla porta USB 3.0 disponibile sul computer.

Connessione Audio / Fare riferimento all'illustrazione riportata di seguito del connettore Audio e al manuale utente per la scheda madre. Selezionare la scheda madre relativa a AC'97 o HD Audio (Azalia) e considerare che il supporto audio è compatibile con AC'97 o HD Audio (Azalia); in caso contrario, le periferiche potrebbero venire danneggiate.

Português

Guia de Instalação Eléctrica

Ligação do LED da Caixa / Na parte dianteira da caixa pode encontrar alguns LEDs e fios eléctricos. Consulte o manual de utilizador do fabricante da sua motherboard e ligue os fios à parte superior do painel na motherboard.

Ligação UBS 2.0 / Consulte o manual da sua motherboard para ver a secção de "Ligação USB".

Ligação USB 3.0 /

1. Certifique-se que a sua motherboard suporta ligação USB 3.0.
2. Ligue o cabo USB 3.0 à porta USB 3.0 disponível no seu computador.

Ligação Áudio / Consulte a imagem seguinte do conector Áudio e o manual de utilizador da sua motherboard.

Selecione a motherboard que utiliza AC'97 ou HD Áudio (Azalia), (verifique se a sua placa de áudio suporta AC'97 ou HD Áudio (Azalia)) ou irá danificar o(s) seu(s) dispositivo(s).

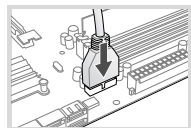
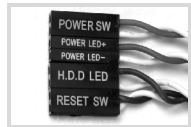

USB 3.0 Connection

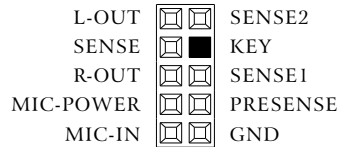

AUDIO AZALIA Function

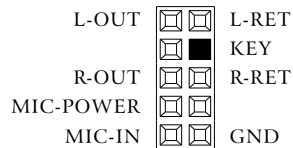

AUDIO AC'97 Function

繁體中文

線材安裝說明

機殼LED連接方式 / 在機殼前方的面板後面，可以找到一些LED與開關線材 (POWER Switch....)，請參考主機板使用說明書，並將機殼上的線材正確地連接到主機板上，這些線材通常都會印有標籤在上面，如果沒有的話，請找出機殼前面板上線材原本的位置以知道正確的來源。

USB 2.0 連接 / 請參考主機板使用手冊找出主機板上的USB連接孔位

USB 3.0 連接 /

1. 請確認主機板是否支援USB 3.0傳輸介面。
2. 連接USB 3.0傳輸線至主機板上的USB3.0接埠。

音效連接 / 請根據下面的音源接頭圖示與主機板使用手冊來連接音效裝置，請確認主機板上的音效裝置是支援AC'97音效或是HD音效(Azalia)，裝置錯誤可能會導致主機板音效裝置的毀損，某些主機板的音效裝置不會與下方的圖示完全相同，請參酌主機板使用手冊以得到正確的安裝資訊。

简体中文

线材安装说明

机壳LED连接方式 / 在机壳前方的面板后面，可以找到一些LED与开关线材 (POWER Switch....)，请参考主板使用说明书，并将机壳上的线材正确地连接到主板上，这些线材通常都会印有标签在上面，如果没有的话，请找出机壳前面板上线材原本的位置以知道正确的来源。

USB 2.0 连接 / 请参考主板使用手册找出主板上的USB连接孔位

USB 3.0 连接 /

1. 请确认主板是否支持USB 3.0传输接口。
2. 连接USB 3.0传输线至主板上的USB3.0接埠。

音效连接 / 请根据下面的音源接头图示与主板使用手册来连接音效装置，请确认主板上的音效装置是支持AC'97音效或是HD音效(Azalia)，装置错误可能会导致主板音效装置的毁损，某些主板的音效装置不会与下方的图标完全相同，请参酌主板使用手册以得到正确的安装信息。

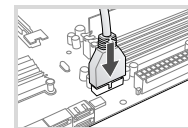
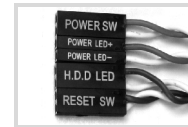

USB 3.0 Connection

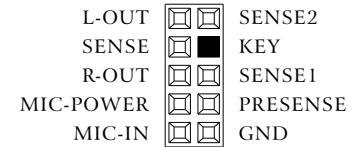

AUDIO AZALIA Function

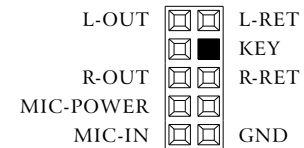

AUDIO AC'97 Function

日本語

リード線の取り付けガイド

ケース LED の接続 / ケース前面には、LEDとスイッチリード線があります。 マザーボードメーカーのユーザーマニュアルを参照し、これらのリード線をマザーボードのパネルヘッダに接続してください。

USB 2.0 の接続 / マザーボードのマニュアルを参照して、「USB接続」のセクションを探します。

USB 3.0 の接続 /

1. お使いのマザーボードがUSB 3.0接続をサポートしていることを確認してください。
2. USB 3.0ケーブルをコンピュータの空いているUSB 3.0ポートに接続します。オーディオ接続 / オーディオコネクタの図とマザーボードのユーザーマニュアルを参照してください。AC'97またはHDオーディオ(Azalia)を使用するマザーボードを選択してください(オーディオがAC'97またはHDオーディオ(Azalia)をサポートしていることを確認してください)。サポートしていないと、デバイスが損傷します。

Русский

Указания по прокладке кабелей

Подключение индикаторов корпуса / В передней части корпуса расположены индикаторы и провода выключателей. Перед подсоединением этих проводов к монтажной колодке панели на материнской плате изучите руководство пользователя производителя материнской платы.

Подключение USB 2.0 / См. раздел «Подключение USB» в руководстве материнской платы.

Подключение USB 3.0 /

1. Убедитесь, что материнская плата поддерживает подключение по стандарту USB 3.0.
 2. Подсоедините кабель USB 3.0 к свободному порту USB 3.0 компьютера.
- Подключение аудиоразъема / См. следующую иллюстрацию аудиоразъема и руководство пользователя материнской платы. Выберите материнскую плату, в которой используется кодек AC'97 или HD Audio (Azalia) (убедитесь, что звуковая плата поддерживает кодек AC'97 или HD Audio (Azalia)). В противном случае можно повредить устройства.

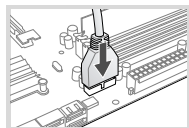
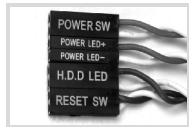

USB 3.0 Connection

L-OUT		SENSE2
SENSE		KEY
R-OUT		SENSE1
MIC-POWER		PRESENSE
MIC-IN		GND

AUDIO AZALIA Function

L-OUT		L-RET
		KEY
R-OUT		R-RET
MIC-POWER		
MIC-IN		GND

AUDIO AC'97 Function

Türkçe

Ara Kablo Kurulum Kılavuzu

Kasa ışık bağlantısı / Kasanın ön kısmında bazı ışıklar ve anahtar ara kabloları görebilirsiniz. Lütfen anakart üreticinizin sağladığı kullanım kılavuzuna bakın ve daha sonra, bu ara kabloları, anakart üzerindeki panel bağlantı noktalarına bağlayın.

USB 2.0 bağlantısı / Lütfen anakart kılavuzunuzun "USB bağlantısı" bölümüne bakın.

USB 3.0 Bağlantısı /

1. Ana kartınızın USB 3.0 bağlantısını desteklediğinden emin olun.
2. USB 3.0 kablosunu, bilgisayarınızdaki kullanılabilir USB 3.0 bağlantı noktasına bağlayın. Ses Bağlantısı / Lütfen aşağıdaki Ses konektörü resmine ve anakartınızın kullanım kılavuzuna bakın. Lütfen AC'97 veya HD Audio(Azalia) spesifikasyonunu kullanan bir anakart seçin (ses sisteminizin AC'97 veya HD Audio (Azalia) spesifikasyonunu desteklediğini unutmayın); aksi takdirde, aygıt(lar)ınız zarar görür.

ภาษาไทย

คู่มือการติดตั้งสายไฟ

การเชื่อมต่อไฟ LED ของเคส / ที่ด้านหน้าของเคส คุณจะเห็นไฟ LED และสายไฟของสวิตซ์ กรณีศึกษาหมายเลขเคสจากผู้ผลิตแผงวงจรหลักของคุณ จากนั้นให้เชื่อมต่อสายไฟเหล่านี้เข้ากับส่วนหัวของแผงบนแผงวงจรหลัก

การเชื่อมต่อ USB 2.0 / กรณีศึกษาหมายเลขเคสจากผู้ผลิตแผงวงจรหลักของคุณ ในหัวข้อ "การเชื่อมต่อ USB"

การเชื่อมต่อ USB 3.0 /

1. ตรวจสอบให้แน่ใจว่าแผงวงจรหลักของคุณรองรับการเชื่อมต่อ USB 3.0
2. เชื่อมต่อสาย USB 3.0 เข้ากับพอร์ต USB 3.0 ที่สามารถใช้งานได้บนคอมพิวเตอร์ของคุณ การเชื่อมต่ออุปกรณ์รับส่งสัญญาณเสียง/ กรณีศึกษาระยะเยื้องจากภาพประกอบของตัวเชื่อมต่อสัญญาณเสียงต่อไปนี้ และคู่มือใช้ของผู้ผลิตแผงวงจรหลักของคุณ กรุณาเลือกแผงวงจรหลักที่ใช้ AC'97 หรือ HD Audio(Azalia) (กรุณาตรวจสอบให้แน่ใจว่าอุปกรณ์รับส่งสัญญาณเสียงของคุณรองรับ AC'97 หรือ HD Audio (Azalia)) มิฉะนั้นอุปกรณ์ของคุณอาจเสียหายได้

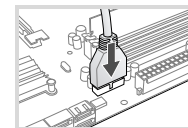

USB 3.0 Connection

L-OUT		SENSE2
SENSE		KEY
R-OUT		SENSE1
MIC-POWER		PRESENSE
MIC-IN		GND

AUDIO AZALIA Function

L-OUT		L-RET
		KEY
R-OUT		R-RET
MIC-POWER		
MIC-IN		GND

AUDIO AC'97 Function

